

# The In-the-Ear Recording Concept

By David Looney, Preben Kidmose, Cheolsoo Park, Michael Ungstrup, Mike Lind Rank, Karin Rosenkranz, and Danilo P. Mandic

**T**he integration of brain monitoring based on electroencephalography (EEG) into everyday life has been hindered by the limited portability and long setup time of current wearable systems as well as by the invasiveness of implanted systems (e.g. intracranial EEG). We explore the potential to record EEG in the ear canal, leading to a discreet, unobtrusive, and user-centered approach to brain monitoring. The in-the-ear EEG (Ear-EEG) recording concept is tested using several standard EEG paradigms, benchmarked against standard on-scalp EEG, and its feasibility proven. Such a system promises a number of advantages, including fixed electrode positions, user comfort, robustness to electromagnetic interference, feedback to the user, and ease of use. The Ear-EEG platform could also support additional biosensors, extending its reach beyond EEG to provide a powerful health-monitoring system for those applications that require long recording periods in a natural environment.

## User-Centered and Wearable Brain Monitoring

Unlike indirect brain imaging approaches derived from blood hemodynamic responses, such as functional magnetic resonance imaging and positron emission tomography, EEG—through electrodes placed along the scalp (on-scalp)—provides a direct measurement of spatially aggregated neural electrical activity at a high temporal resolution. This makes it a convenient means to detect the onset of brain disorders or an epileptic seizure, analyze causality between external stimuli and brain responses, or reveal relations

between responses. Recently, EEG has also been employed in the laboratory environment in emerging interactive applications, such as the study of attention, fatigue, and microsleap; neuroprosthetics and brain computer interface (BCI); biometric authentication; and neuroeconomics. These applications typically require long recording periods and an online mode of operation.

Despite the clinical advantages of EEG, there are several issues that prevent its widespread use. Current systems are cumbersome, with long leads connecting the electrodes to a biosignal amplifier, and require the assistance of a trained person to set up the recording session and perform electrode placement, the electrode impedance check, and the

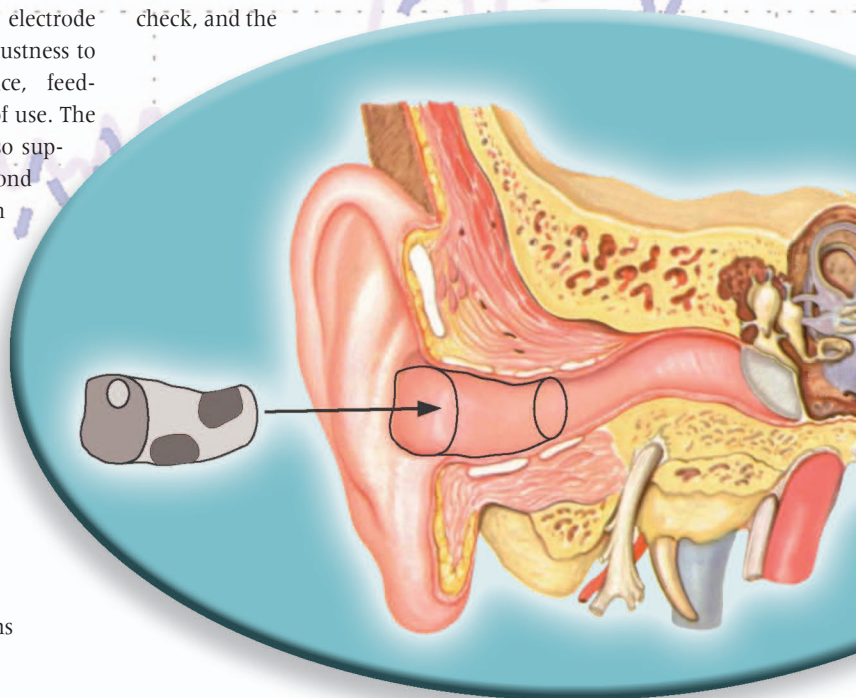

Digital Object Identifier 10.1109/MPUL.2012.2216717

Date of publication: 11 December 2012

startup procedure for the biosignal amplifier. Therefore, applications are often restricted to controlled environments, limiting the use of EEG to inpatient monitoring or laboratory recordings. The high overhead costs and the inconvenience to the user inherent in the on-scalp system have motivated research into portable devices that permit the use of EEG in daily life.

In the 1970s, developments in miniature pre-amplifiers and continuous recording technology based on cassette tapes led to the first ambulatory EEG (AEEG) systems [1], enabling outpatient monitoring for up to 24 h. Ambulatory EEG has become invaluable in, for instance, seizure diagnosis as it is a cost-effective means of monitoring patients in their homes for long periods of time—a prerequisite for detecting seizure events that are often missed by standard brief EEG recordings (often limited to 20 min). The digitization of recording platforms, coupled with the integration of computer technology, has provided even greater portability, and current recording systems can operate for 24 h with up to 32 channels, greatly enhancing the usefulness of EEG in applications. However, many AEEG systems still inherit the problems related to standard EEG recording systems and remain prohibitively large (weighing hundreds of grams), making long-term recordings of patients carrying out normal activities in their natural environments impractical.

The limitations of AEEG have led to research on new portable devices that miniaturize the recording system and that enable measurements over long time periods in natural environments, so-called wearable systems [2]. There are, however, many factors that make robust wearable systems a significant challenge. For instance, the wet nature of conventional electrodes (requiring the use of conductive gel to enable a connection between the electrodes and the scalp) makes them unsuitable for 24-h use, as the recording quality degrades considerably once the gel dries out. The use of electrode gel also leaves residue, and users need to wash their hair at the end of a recording session, an additional inconvenience. While recent advances in gel-free electrode technologies can significantly enhance the wearable operation of recording systems, these do not address the inherent problems of on-scalp electrodes, which are easily dislodged and require support through an EEG cap or electrode adhesives to keep them in position. They also call attention to the fact that the user is being monitored, since the electrodes and lead wires, as well as the cap keeping them in place, are clearly visible.

Furthermore, the rigid on-scalp electrodes can be uncomfortable and limit the fidelity of recordings. Miniaturization of the amplifier and recording devices is also restricted by existing battery technology, as prohibitively large batteries are required for

The limitations of AEEG have led to research on new portable devices that miniaturize the recording system and that enable measurements over long time periods in natural environments, so-called wearable systems.

data logging and transmission for many electrodes over long periods of time. Signal processing could help; however, while advanced data compression algorithms can reduce the transmission costs (50% reduction in raw data using lossless compression techniques), the implementation of such algorithms is not straightforward given the power limitations [2], while the degree of compression is typically worse for real-world, noisy recordings.

One way to alleviate the problems associated with wearable EEG is the use of semi-implanted electrodes, which offer high-quality recordings with well-concealed and rigidly held in-place electrodes. Even so, the technology is used only for a very small number of patients suffering from severe or life-threatening conditions, as the setup process is significantly more cumbersome and the electrodes must be inserted by a clinician. There is also the issue of higher costs, discomfort to the user, and the infection risk posed with this approach.

It is clear that any practical wearable EEG system is subject to a tradeoff between recording quality, convenience to the user, patient privacy, cost of recording, and the level of obtrusiveness. This suggests that a fully wearable EEG system must exhibit the following characteristics:

- ▼ *Discreet*: A wearable system should not be clearly visible or stigmatizing. In the past, successful integration of a technology with daily life, as in the case of hearing aids, has only been achieved once it has been made suitably discreet, even if this comes at the cost of reduced performance.
- ▼ *Unobtrusive*: The recording device should be comfortable to wear and should impede the user as little as possible. Unobtrusiveness is necessary to ensure high fidelity of recordings when users are monitored in their natural environments. In the study of sleep, for example, it is crucial that the recording system does not influence the sleep habits of the user so that an accurate diagnosis can be obtained.
- ▼ *Robust*: The system must be embedded onto a device that ensures the electrodes are firmly held in position and will not become easily dislodged during use.
- ▼ *User friendly*: Users should be able to insert the device themselves without the assistance of a trained person. Such devices should easily be maintained by the user (e.g., battery replacement), resulting in a significant reduction in operational costs.
- ▼ *Feasible*: The device should be realistic to implement, given limitations in present-day technology (tradeoff between recording time, number of channels, noise floor, signal processing capacity, and battery capacity or size).

We illuminate how an Ear-EEG system fulfills the above requirements, as it exhibits a high degree of comfort and excellent long-term wearability, at the expense of a reduced number of electrodes and thus a compromise in recording quality. Comprehensive experiments for standard EEG paradigms show that the signal-to-noise ratio (SNR) of the Ear-EEG approach is on par with on-scalp EEG and, owing to the



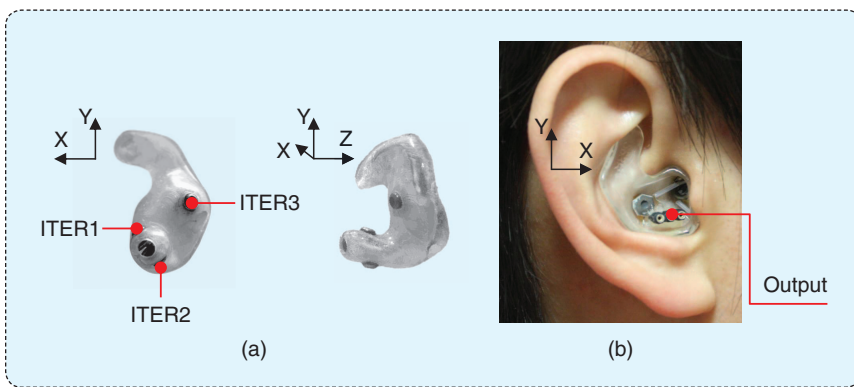

**FIGURE 1** Ear-EEG earpieces used in the preliminary study, as described in [3], for different orthographic planes. (a) The earpiece shown is for the right ear and has three electrodes (denoted by ITER1, ITER2, and ITER3). (b) The fitted earpiece.

electrode locations, some critical artifacts (eye blinks) are also diminished. There are a number of applications, clinical and nonclinical, for which a small number of electrodes are sufficient, and for which a fully wearable recording platform

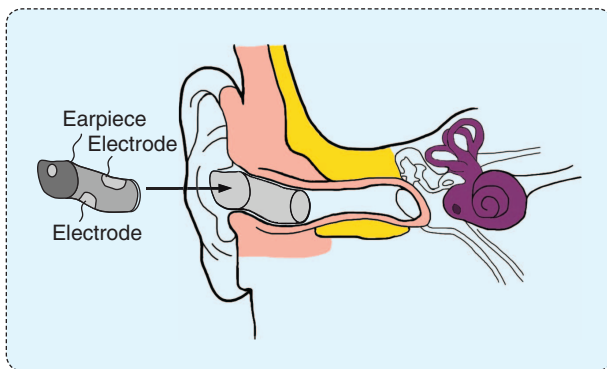

**FIGURE 2** Sketch of a right Ear-EEG earpiece with embedded electrodes shown relative to the ear and ear canal. The earpiece does not enter the ear by more than 10 mm and does not enter the part of the ear canal surrounded by bone.

is a prerequisite. In addition, owing to the wireless links in the modern hearing-aid platforms, the Ear-EEG device has the potential to serve as a node in wearable and wireless body sensor networks.

### Ear-EEG

The proposed Ear-EEG approach, as shown in Figure 1, is radically new in that it records EEG from within the ear canal, which is achieved by embedding electrodes on a customized earpiece (similar to earplugs used in hearing-aid applications).

Both in terms of the propagation of

the brain electric potentials and the recording technology, Ear-EEG uses the same principles as standard recordings obtained from on-scalp electrodes. In electrophysiological terms, bioelectrical signals from the cortex are attenuated by the cerebrospinal fluid, skull, and skin before reaching the ear canal, as is the case with conventional scalp measurements. In electrical terms, Ear-EEG uses the same electrode material, amplifiers, and principles as on-scalp EEG. Crucial advantages of Ear-EEG compared to existing methods are summarized as follows:

- ▼ The earpieces are personalized, comfortable to wear, discreet, and are easy to put in place by the users themselves, facilitating everyday use.
- ▼ The spatial localization of the electrodes, embedded on the surface of the earpiece, is very accurate. This leads to perfect repeatability of the experiments, since the electrodes will always be placed in the same position relative to signal sources and with the same distance between electrodes.
- ▼ The tight fit between the customized earpiece and the ear canal guarantees that the electrodes are held firmly in place, diminishing motion artifacts.

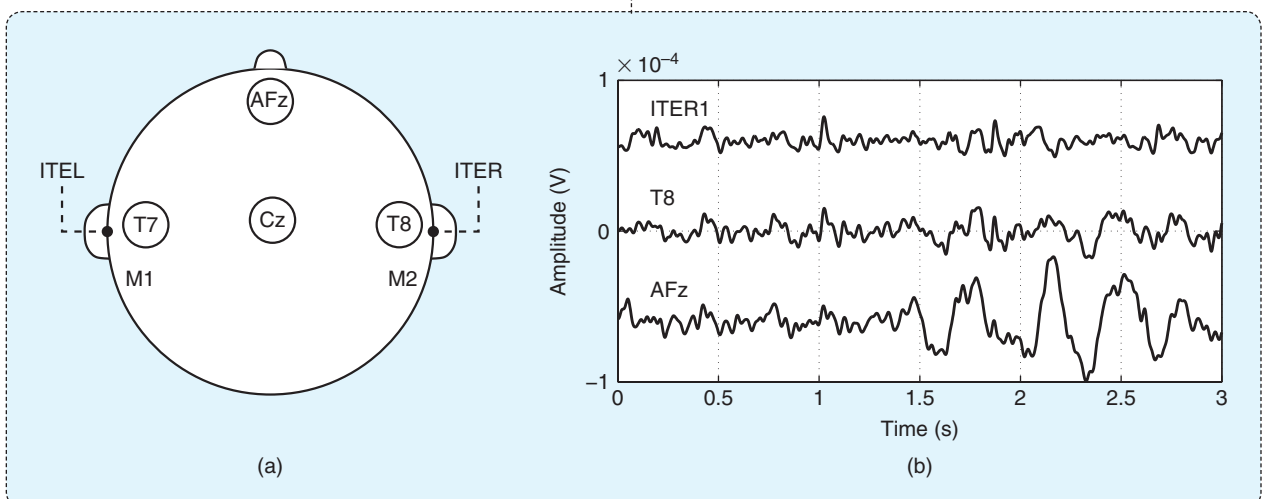

**FIGURE 3** Time waveforms for Ear-EEG and on-scalp EEG. (a) Montage in accordance with the 10–20 system. (b) EEG waveforms for selected Ear-EEG (ITER1) and scalp electrodes (T8, AFz) over 3 s, with consecutive eye blinking starting at 1.5 s. We observe similar waveforms for the period before the eye blinking and that the Ear-EEG signal exhibits a suppression of electrooculogram artifacts.

- ▼ Muscle artifacts are greatly reduced as there are no muscle fibers in the ear canal and common sources of muscle artifacts, such as the face and eye muscles, are located far away.
- ▼ The ear canal is a cavity enclosed by an electrical conductive medium (skin, fluids, brain tissue), reducing the interference from external electrical fields. Interference from external magnetic sources is also diminished as the area spanned by the measurement loop of the leads is very small.
- ▼ The orthoplastic earpieces provide a rigid support for the electrodes, and leads from the electrodes to the electronic instrumentation can be embedded within the earpiece,

In electrical terms, Ear-EEG uses the same electrode material, amplifiers, and principles as on-scalp EEG.

providing a robust, integrated device that can be worn and operated by the users themselves.

### Prototype Ear-EEG System

The Ear-EEG concept was validated by comparing standard on-scalp recordings with a prototype Ear-EEG recording system. The prototype is based on customized hearing-aid earplugs, the manufacturing of which is standard in modern hearing aids, based on wax impressions of the users' ears (concha and outer part of the ear canal). The impression is digitized by a three-dimensional (3-D) scanner, providing a model of an earplug in a CAD program, and is fabricated by additive manufacturing (3-D printing). The electrodes are

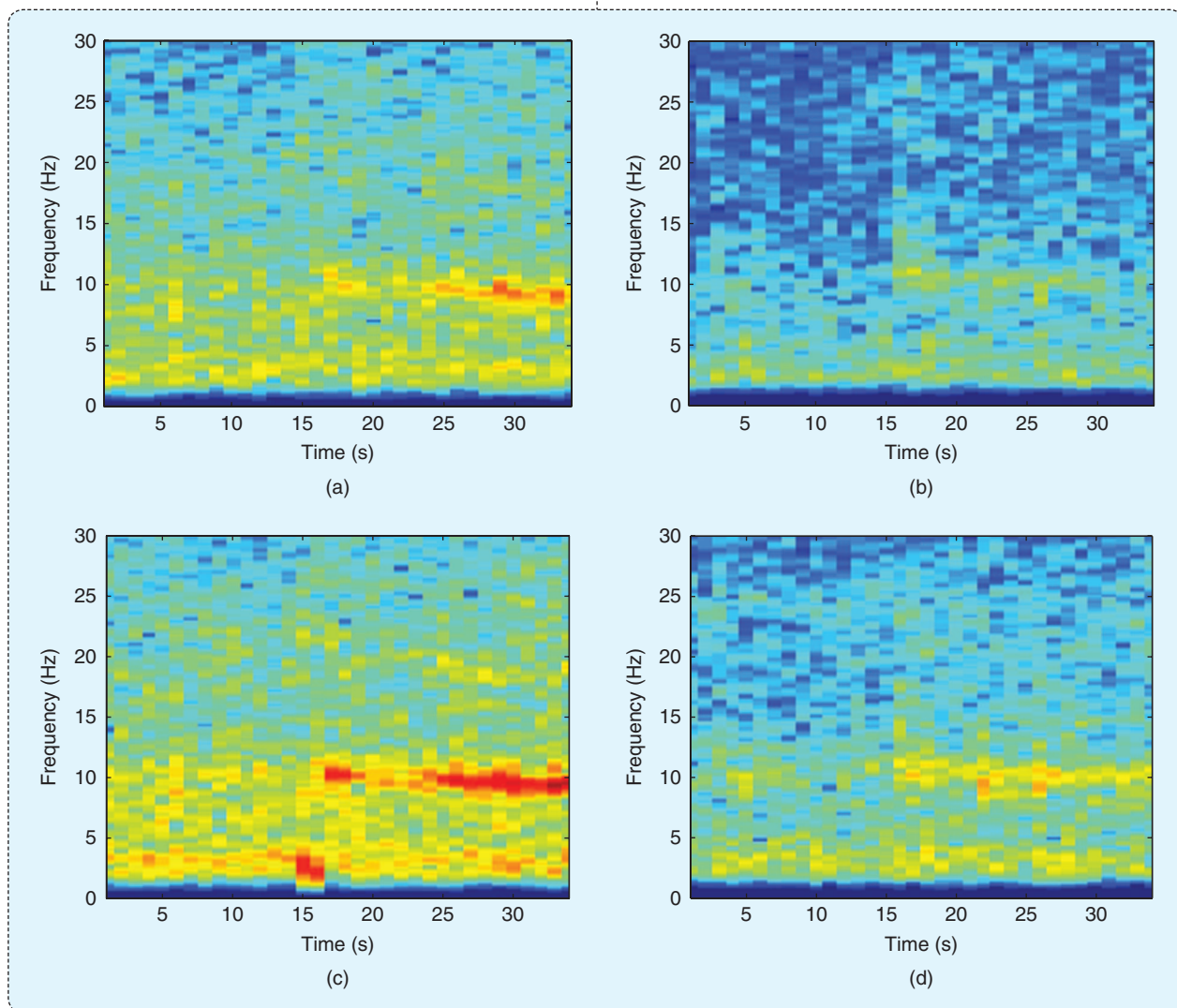

**FIGURE 4** Comparison of AAR. The time-frequency plots show the increased alpha activity (8–12 Hz band) that occurs when the eyes are closed, alpha attenuation is closely linked to the state of alertness or drowsiness. The subjects were instructed to keep their eyes open until instructed by an auditory stimulus to close their eyes after 15 s, eliciting an increase in alpha band power in both scalp and Ear-EEG electrodes. The data were recorded at a sampling frequency of 512 Hz and bandpass filtered using a fifth-order Butterworth filter so as to occupy the frequency range 2–45 Hz. A 2-s sliding Hamming window with 50% overlap was used to obtain the short-time Fourier transform (STFT) spectrum. The time-frequency spectrograms, obtained from five trials for each subject, were averaged. Note the increase in alpha band power at 15 s and an excellent match between the Ear-EEG and on-scalp electrodes. (a) Subject A, Ear-EEG electrode ITER2. (b) Subject B, Ear-EEG electrode ITER2. (c) Subject A, on-scalp electrode T8. (d) Subject B, on-scalp electrode T8.

made from silver/silver chloride (Ag/AgCl) and mounted in holes in the earplug such that the electrodes protrude slightly from the external surface of the earplug. All electrodes are attached with silver wire to a connector to which a standard EEG recording system can be connected. Each earplug comprises two or more electrodes. Figure 1 shows three orthographic planes of one of the earpieces used in the preliminary study described by Looney et al. [3]. Observe that the earplugs are hollow, so as to allow sounds to pass into the ear canal. Figure 2 shows a sketch of the right Ear-EEG earpiece and its approximate position relative to the ear. The ear canal (from pinna to eardrum) is, on average, 26 mm long and 7 mm in diameter; the ear-piece does not enter the ear by more than 10 mm and does not

The prototype Ear-EEG recording system is the first fundamental step toward a ubiquitous fully wearable device suitable for long-term continuous use.

approach the part of the ear canal surrounded by bone.

### Quality of Ear-EEG Recordings

The Ear-EEG recordings were performed simultaneously with on-scalp electrodes, and using the same amplifier, ground and reference electrodes, so as to enable a fair comparison. The in-the-ear (ITE) electrodes of the Ear-EEG prototype are denoted by ITEL and ITER for the left and right ears respectively [see Figure 1 and Figure 3(a)]. Experiments were conducted on two subjects, based on the ITEL1, ITEL2, ITER1, and ITER2 Ear-EEG electrodes, and mastoid (M1 and M2), temporal (T7 and T8), and central (AFz and Cz) on-scalp electrodes [see Figure 3(a)]. The reference position was the

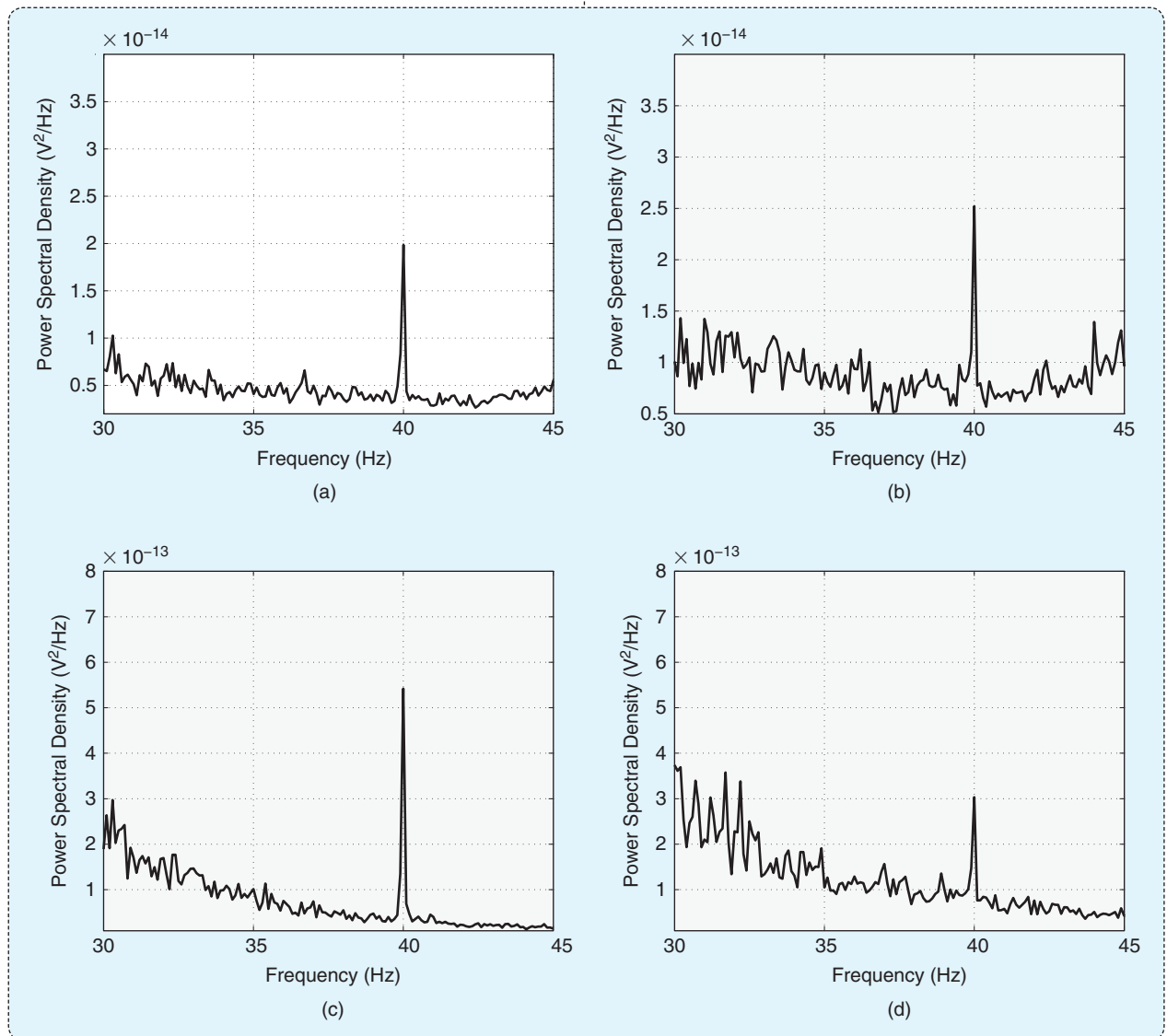

**FIGURE 5** A comparison of ASSR. An amplitude-modulated tone causes increased EEG activity at the modulated frequency and its harmonics. The ASSR is generated in the primary auditory cortex. The subjects attended a 1,000-Hz tone for 200 s (sampling frequency 22.05 kHz), amplitude modulated at 40 Hz. The STFT spectrogram was produced using a 10-s sliding Hamming window with 10% overlap and averaged across time. The ASSR at 40 Hz is visible in both the Ear-EEG and scalp electrodes. (a) Subject A, Ear-EEG electrode ITEL1. (b) Subject B, Ear-EEG electrode ITEL1. (c) Subject A, on-scalp electrode Cz. (d) Subject B, on-scalp electrode Cz.

right earlobe, while the ground electrode, responsible for the reduction of common-mode interference via positive negative [a configuration known as a driven right leg (DRL) circuit], was placed on the chin. Both the on-scalp and Ear-EEG recordings used conductive gel, and the ear canal was first cleaned to remove ear wax.

Figure 3(b) shows a 3-s time window of the recorded signals from electrodes AFz, T8, and ITER1 with consecutive eye blinks starting at 1.5 s. One can observe similar waveforms for the period before the eye blinks, and that the Ear-EEG signal exhibits a suppression of electro-oculogram artifacts as indicated by their lower amplitude. A comparison between the AFz, T8, and ITER electrodes illustrates that Ear-EEG signals have lower amplitudes compared to on-scalp EEG signals, but exhibit similar SNR to scalp signals, as the noise and artifacts are also suppressed.

The potential of the Ear-EEG system in wearable applications was also assessed for three well-known EEG paradigms, for which brain responses were analyzed in the time, frequency, and time-frequency domains and compared with simultaneously recorded on-scalp EEG. The three paradigms considered were as follows:

- 1) The alpha attenuation response (AAR), where increased alpha activity (8–12 Hz band) occurs when subjects close their eyes, which is closely linked to the state of alertness or drowsiness. Figure 4 shows results based on the averaged spectrogram obtained over five trials of a length of 35 s.
- 2) The auditory steady-state response (ASSR), where the subject is presented with an amplitude modulated tone causing a peak in EEG activity at the frequency of the envelope (see Figure 5). The ASSR is generated in the primary auditory cortex, illustrating that ITE EEG can detect auditory-based responses.
- 3) The time-domain visual event-related potential elicited 300 ms after a low-probability target stimulus, the so-called P300 response (see Figure 6). Properties of the P300 response (amplitude, latency) are closely related to cognitive function.

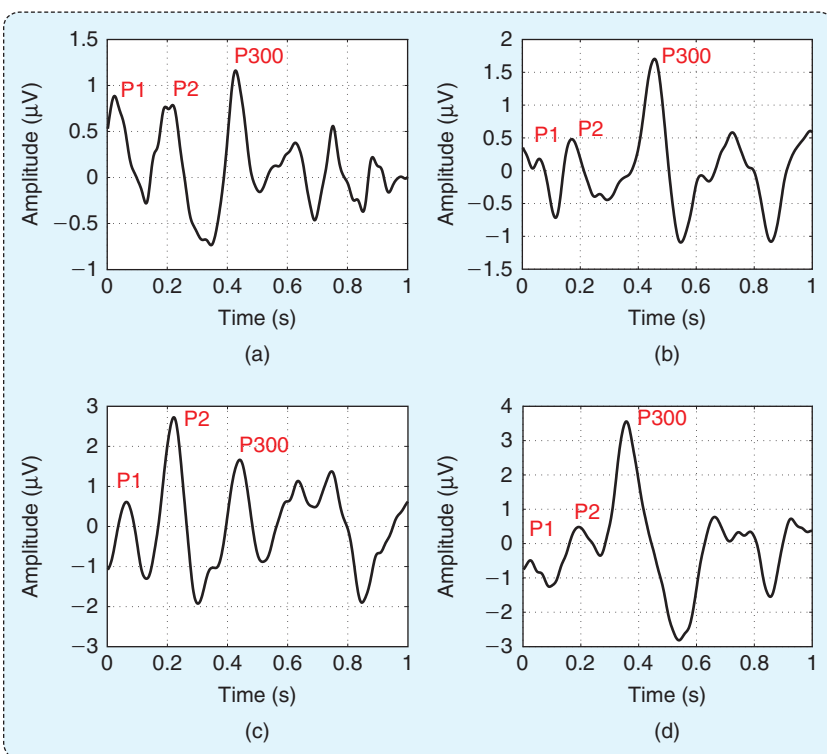

**FIGURE 6** Visual event-related potential. A low-probability target stimulus elicits a time wave in the EEG, the so-called P300 response, approximately 300 ms after stimulus onset. Properties of the P300 response (amplitude, latency) are closely related to cognitive function. The visual stimulus, a symbol of approximate size  $3 \times 3$  cm, was presented on an LCD screen with the subject seated at a distance of approximately 50 cm from the screen. The stimulus was presented randomly, 120 times over a period of 180 s, with a stimulus duration of 50 ms. The data were recorded at a sampling frequency of 512 Hz and were filtered using an empirical mode decomposition-based filter with a high frequency cutoff of 8 Hz. The 1 s of poststimulus data was averaged over the 30 segments that followed the largest interstimulus intervals for both scalp and Ear-EEG electrodes. Note that a P300 response is clearly visible within 300–500 ms of the stimulus for both Ear-EEG and scalp electrodes. Also, observe that other components of the event-related potential are visible in the Ear-EEG trace—the P1 and P2 components at approximately 100 ms and 200 ms, respectively. (a) Subject A, Ear-EEG electrodes ITER1 and ITER2 (time-averaged). (b) Subject B, Ear-EEG electrodes ITER1 and ITER2 (time-averaged). (c) Subject A, on-scalp electrode Cz. (d) Subject B, on-scalp electrode POz.

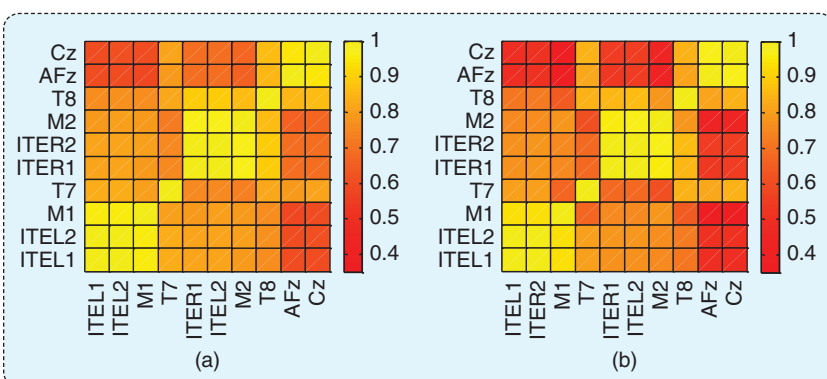

**FIGURE 7** Correlation analysis between the Ear-EEG and on-scalp electrodes for Subject A, for eyes open and eyes closed cases, on the alpha attenuation recordings shown in Figure 4. As expected, the degree of correlation between the scalp and Ear-EEG electrodes is higher for scalp electrodes placed near the temporal region. To obtain more accurate correlations, the frequency range considered was wider than the analysis shown in Figure 4. A fourth-order Butterworth notch filter was applied to remove interference in the frequency range 48–52 Hz, and an additional eighth-order Butterworth bandpass filter was applied to retain frequencies in the range 2–200 Hz. (a) Subject A, correlation (eyes closed). (b) Subject A, correlation (eyes open).

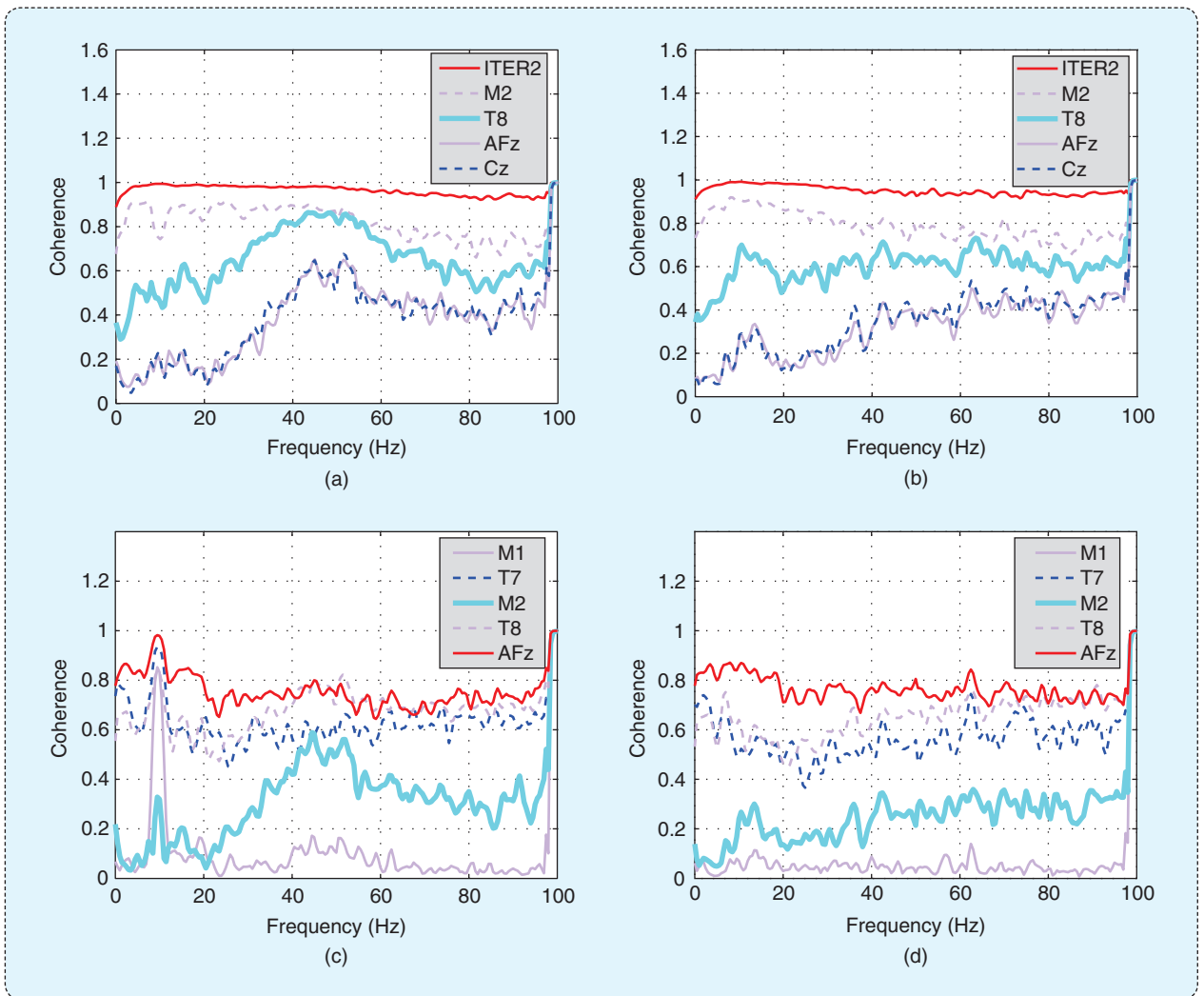

**FIGURE 8** Average spectral coherence results for Subject A for the alpha attenuation recordings shown in Figure 4 with reference to ITER1 [(a) and (b)] and, for comparison, the scalp electrode Cz [(c) and (d)]. Conforming with our previous analysis in Figures 3(b) and 7, the degree of coherence between the scalp and Ear-EEG electrodes is higher for scalp electrodes placed near the temporal region. The signals were conditioned with a fourth-order Butterworth notch filter to remove the AC interference in the frequency range 48–52 Hz. A subsequent eighth-order Butterworth bandpass filter was applied to retain frequencies in the range 2–200 Hz. The figures illustrate the average coherence over five trials for segments of length 15 s when the eyes of the subject were open and closed. (a) Subject A, coherence with respect to ITER1 (eyes closed). (b) Subject A, coherence with respect to ITER1 (eyes open). (c) Subject A, coherence with respect to Cz (eyes closed). (d) Subject A, coherence with respect to Cz (eyes open).

In particular, its association with attention makes it a widely used paradigm in BCI studies.

In all the case studies, we observed a good match between the Ear-EEG and on-scalp responses. Even though the Ear-EEG had lower absolute amplitudes than on-scalp EEG, they had a similar relative ratio between the desired activity and the background signal (background EEG and noise), that is, a similar SNR. This is next confirmed by statistical correlation and coherence analyses for the alpha attenuation experiment described in Figure 4.

Figure 7(a) shows the correlation analysis for Subject A for 15s of recorded activity averaged over 5 trials, where the eyes of the subject were open and unmoving (no motion artifacts). The results show that there was a high correlation between Ear-EEG electrodes located in the same ear, i.e., between ITER1 and ITER2 and between ITEL1 and ITEL2, and the degree of correlation between the on-scalp and Ear-EEG electrodes was

higher for on-scalp electrodes placed near the temporal region (T7, T8) and electrodes placed at the mastoid (M1, M2). Figure 7(b) shows the correlation analysis for Subject A for 15 s of recorded activity averaged over five trials where the eyes of the subject were closed. The results follow the same pattern as those in Figure 7(a).

Spectral coherence reflects the degree of similarity between two signals across frequency. Coherence values lie in the range [0, 1], and values close to 1 indicate that at a given frequency the spectral contents of the two signals are closely matched. Figures 8 and 9 show the degree of spectral coherence between Ear-EEG electrodes and on-scalp electrodes for Subject A and Subject B. For comparison, the spectral coherence values obtained between the on-scalp electrode Cz and other on-scalp electrodes are also shown, illustrating similar coherence patterns to those for Ear-EEG electrodes. As with the correlation results, the degree of

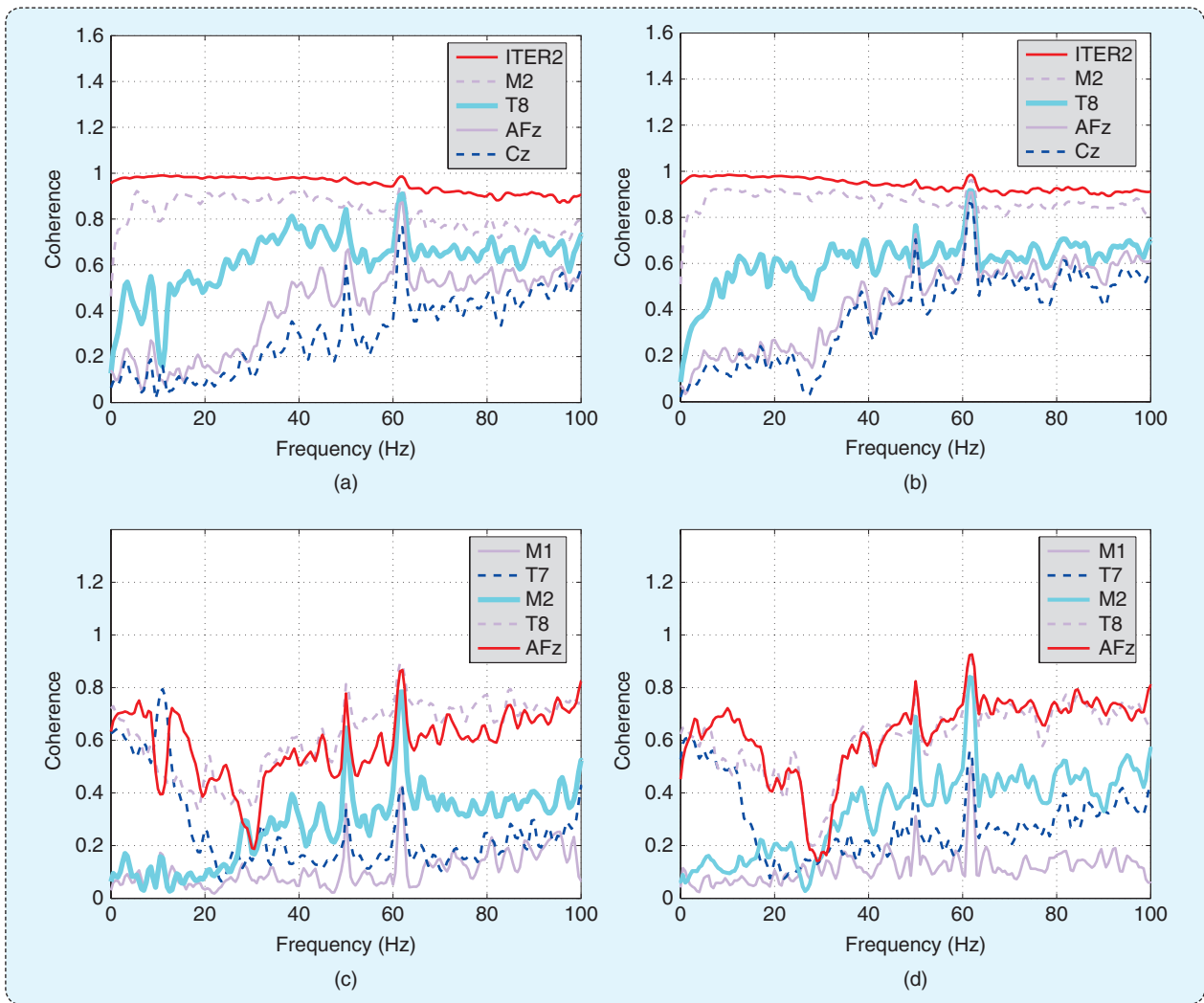

**FIGURE 9** Average spectral coherence results for Subject B for the alpha attenuation recordings shown in Figure 4 with reference to ITER1 [(a) and (b)] and, for comparison, the scalp electrode Cz [(c) and (d)]. Conforming with our previous analysis in Figures 3(b) and 7, the degree of coherence between the scalp and Ear-EEG electrodes is higher for scalp electrodes placed near the temporal region. The signals were conditioned with a fourth-order Butterworth notch filter to remove the AC interference in the frequency range 48–52 Hz. A subsequent eighth-order Butterworth bandpass filter was applied to retain frequencies in the range 2–200 Hz. The figures illustrate the average coherence over five trials for segments of length 15 s when the eyes of the subject were open and closed. (a) Subject B, coherence with respect to ITER1 (eyes closed). (b) Subject B, coherence with respect to ITER1 (eyes open). (c) Subject B, coherence with respect to Cz (eyes closed). (d) Subject B, coherence with respect to Cz (eyes open).

coherence between the Ear-EEG electrodes and the neighboring on-scalp electrodes (T7, T8) was high, decreasing for more distant on-scalp electrodes. These results are consistent with the degrees of coherence between Cz and other on-scalp electrodes.

More in-depth analysis of Ear-EEG for a broad class of auditory evoked potentials can be found in [4], where it is shown that the SNR of Ear-EEG responses can match those of on-scalp EEG.

### Applications of Ear-EEG

Conventional and ambulatory EEG systems have widespread use within clinical practice and in broad fields of neuroscience. As a natural evolution from ambulatory EEG, future wearable systems will become commonplace in brain monitoring in many of these fields [2]. Although the proposed Ear-EEG approach requires further validation, comprehensive comparison across the data analysis domains (time, frequency,

time-frequency) in Figures 4–6 illustrates that it can detect a wide range of EEG responses, particularly those detectable in the temporal region. As such, Ear-EEG represents a feasible model of achieving the necessary portability at a tradeoff in the freedom of electrode positioning and spatial resolution, opening new possibilities in both the clinical context and for general EEG use in everyday life. Applications that will most benefit from the proposed platform are those that require only a small number of electrodes and where portability is paramount, for instance, seizure detection (absence epilepsy) or microsleep detection (fatigue monitoring).

The noninvasive and inexpensive nature of Ear-EEG promises to make it a convenient means for BCI, where the cumbersome nature of standard recording equipment limits its widespread use. For instance, the results in Figure 6 show that the prototype can detect the visual P300 response, which is elicited in response





(a)

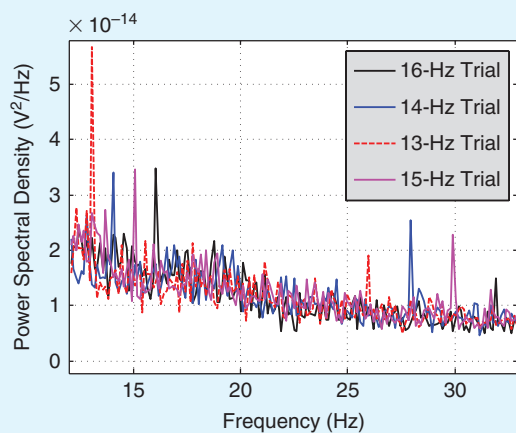

(b)

**FIGURE 10** Proof-of-concept Ear-EEG BCI study. A healthy subject participated in an experiment wherein they attended a visual stimulus—a grid of light-emitting diodes flashing at different frequencies. Visual stimuli flashing at frequencies between 1 and 100 Hz elicit increased activity at the same frequency in EEG, known as the steady-state visual evoked potential (SSVEP). The high SNR of the response makes it a focus of BCI research. The average power spectral density over all ITE electrodes is shown in (b) as the subject selectively attended each of the stimuli for four 120-s trials. Note that SSVEPs are clearly visible at the stimuli frequencies (13–16 Hz) and at the first harmonics so that the attended stimulus for each trial can be easily estimated. These results clearly illustrate the potential of Ear-EEG in BCI.

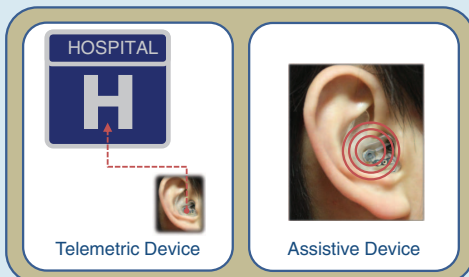

(a)

(b)

**FIGURE 11** Communication pathways for assistive and telemetric wearable devices. The Ear-EEG device will record and analyze EEG and will either (a) communicate data and/or data descriptors to a clinical base—a telemetric device—or (b) relay brief instructions directly to the user—an assistive device.

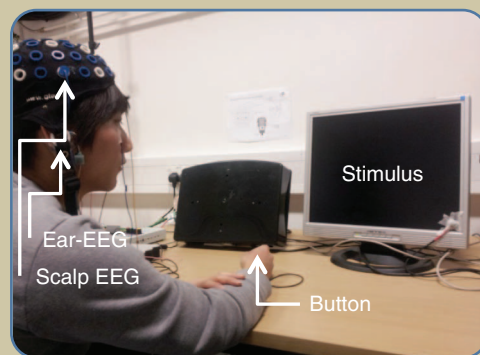

(a)

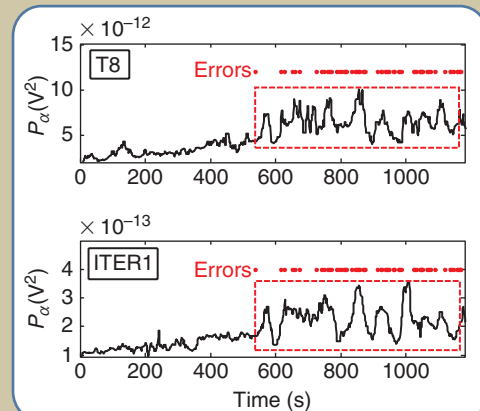

(b)

**FIGURE 12** Proof-of-concept Ear-EEG alertness study. A naive and healthy subject participated in an experiment wherein they attended a visual stimulus—a white square at the center of a monitor that was presented briefly (<1 s) and at random intervals (approximately 20 times/min) for a duration of 1,200 s. (a) The subject was seated comfortably at the monitor and instructed to communicate the presence of the stimulus via a button press while Ear- and on-scalp EEG was recorded. The setup is depicted in (a) where, for illustration, the strap of the EEG cap has been loosened to reveal the ear. To enhance the likelihood of reduced performance (alertness) over time, the subject was instructed to limit their sleeping hours the night before the experiment. The subject accurately detected all stimuli for the first 500 s of the recording. At 540 s, the subject made their first error by failing to press the button in response to the stimulus, followed by several other errors over the remainder of the recording. Power in the alpha band ( $P_{\alpha}$ ), observed using the scalp (T8) and Ear-EEG electrodes (ITER1), is shown in (b). A strong correlation is observed between the number of subject errors and the signal  $P_{\alpha}$ , both in terms of its average value and variability [see segment of  $P_{\alpha}$  highlighted in (b) where individual errors over time are also shown]. This study illustrates the use of Ear-EEG in monitoring fatigue for scenarios that require vigilance (air traffic control, driving).

to task-relevant stimuli and forms the basis for a number of BCI paradigms. Similarly, acoustical stimuli cause systematic changes in the EEG, and the position of the Ear-EEG electrodes near the temporal region (the location of the primary auditory cortex) suggests the usefulness of Ear-EEG in the emerging area

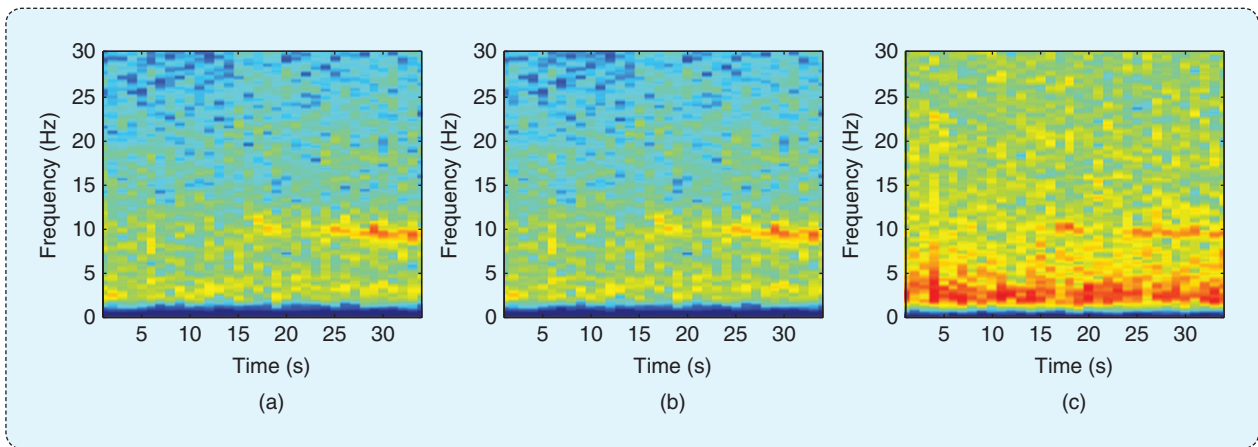

**FIGURE 13** AAR results revisited (see Figure 4)—feasibility of an in situ Ear-EEG system. Parts (a) and (b) show, respectively, the time-frequency analysis of the AAR results obtained with the Ear-EEG electrodes ITER1 and ITER2 using the earlobe (A2) as a reference. (c) The time-frequency plot for the difference between the two Ear-EEG electrode recordings, indicating that the AAR paradigm can be performed using Ear-EEG electrodes only.

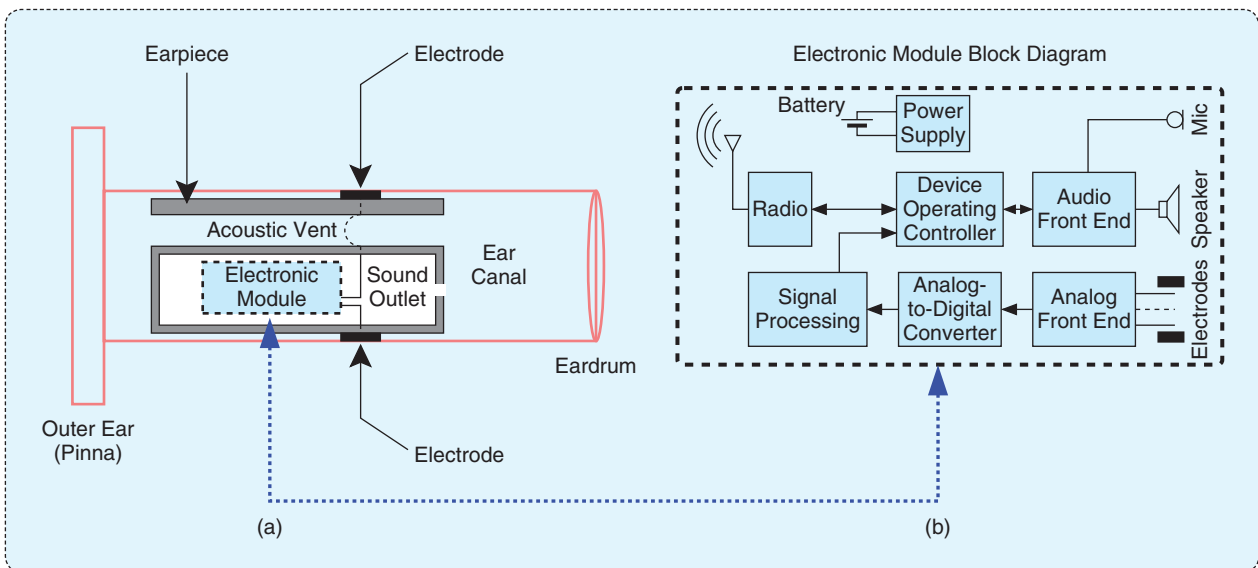

**FIGURE 14** (a) A cross-sectional sketch of an earpiece, similar to the earpiece depicted in Figure 2, with electrodes embedded on the surface and containing an electronic module. (b) The electronic module comprises instrumentation for the electrode signals, analog-to-digital conversion, a signal processing unit, a battery, and a radio module.

of auditory BCI. This is illustrated by the ASSR experiment, as shown in Figure 5, for which the cortical generators are located in the auditory cortex. The usefulness of Ear-EEG in visual-stimulus-based BCI is illustrated in Figure 10, showing how an ear-based device can be used to communicate several commands using a visual-stimulus interface.

The Ear-EEG platform is very versatile and allows us to distinguish between two modes of operation of future devices: assistive and telemetric (see Figure 11). A telemetric device will record and transmit either entire data segments, or sufficient data descriptors, to support diagnosis, the tracking of diseases, or the evaluation of treatment by clinicians. They would be of use, for instance, in treatment evaluation of childhood epilepsy or of various sleep disorders and psychiatric diseases. An assistive Ear-EEG device will perform an automated analysis of the EEG (in

situ or via an external processing device) to detect and identify application-specific events communicated directly to the user or caretakers. Applications include warnings for insulin-treated diabetics against impending hypoglycemic seizure or monitoring the frequency and length of seizures in childhood absence epilepsy. Figure 12 illustrates the assistive mode of operation of Ear-EEG on an alertness study, similar to the one recently proposed with on-scalp electrodes placed in the neighboring mastoid region [5].

### Future Opportunities for the Ear-EEG System

The prototype Ear-EEG recording system is the first fundamental step toward a ubiquitous fully wearable device suitable for long-term continuous use. With further technical development and clinical research, we envisage that, similar to the hearing

aid, Ear-EEG will be a tiny battery-powered brain-monitoring device that performs both the recording and signal processing in situ. For this article, and for a fair comparison with on-scalp EEG, the prototype was connected to an external amplifier and the ground (common-mode) and reference electrodes placed on the chin and earlobe, respectively. However, all electrodes of the future Ear-EEG system will be centered on the earpiece itself (see Figure 13 for a feasibility study). Since the system is battery powered, there will be no requirement for a ground electrode. Figure 14 depicts this proposed system: Figure 14(a) shows a cross-sectional view of an earpiece comprised of electrodes, an acoustical vent to diminish acoustic occlusion, and an electronic module. A block diagram for the electronic module is shown in more detail in Figure 14(b), containing analog instrumentation for the electrode signals; circuitry for analog-to-digital conversion of the bioelectric signals and digital signal processing; a means for wireless communication between the left and right earpieces and to external devices; a subsystem for providing acoustical warnings to the user; and a microphone to monitor the acoustic environment.

This fully integrated in-ear approach, supported by gel-free electrode technology, promises a number of practical advantages:

- ▼ diminished sensitivity to interference caused by electrical equipment in the recording environment (computers, electric lights, radios), due to the reduced strength of electric fields in the ear canal and the short distances between the system leads and the amplifier
- ▼ conductive gel-free recordings (supported by, e.g., capacitive electrode technology) without the need for skin preparation
- ▼ reduced sensitivity to ear wax and hair
- ▼ diminished motion artifacts, due to the absence of a metal-electrolyte interface.

The functionality of the proposed Ear-EEG platform can be readily extended beyond EEG to include other physiological parameters. Several recent results have supported the ear as a natural sensing location for health monitoring as well as advances in sensor miniaturization. The combined information of brain activity, cardiovascular and respiratory function, and user motion would enable a significantly enhanced health monitoring device and greater robustness to noise and artifacts.

One possible technology to be integrated into Ear-EEG is reflective photoplethysmography, which operates by detecting modulations in reflected light to determine key parameters of cardiovascular function (heart rate and arterial blood oxygen saturation), and can be recorded from an ear-worn sensor [6]. Also, the ear canal is frequently used for measuring core body temperature, while analysis of respiratory sounds sensed in the ear is another possible noninvasive approach to evaluating the respiratory function [7]. Accelerometers are widely used in movement estimation due to their small size, low cost, and low-power requirements, making them suitable for integration into the Ear-EEG platform. In fall detection, a recent study has shown that the performance of devices worn behind the ear at head level exceeds that of systems placed at the hip or waist [8].

With the Ear-EEG concept, a new approach to monitoring brain electrical activity has been proposed in order to meet

demands of applications where the primary requirements are robust, wearable, and user-friendly devices capable of long-term recordings in a natural environment. Our prototype has demonstrated a number of potential advantages for portable monitoring over existing on-scalp systems. Although the full extent to which Ear-EEG can replace standard on-scalp recordings remains to be seen, it has been validated for the extraction of several key EEG features, including the AAR, ASSR, and P300 paradigms.

The imminent integration of a recording and processing system in an earplug represents a quantum step forward in the evolution of portable EEG. Together with the development of robust and real-time algorithms for the prediction and detection of different EEG paradigms, and integration of other sensors, the Ear-EEG platform lends itself to opening new research avenues in healthcare, neuroscience, and in a number of emerging applications in real life.

*David Looney, Cheolsoo Park, and Danilo P. Mandic (d.mandic@imperial.ac.uk) are with the Department of Electrical and Electronic Engineering, Imperial College London, United Kingdom. Preben Kidmose is with the Aarhus School of Engineering, Aarhus University, Denmark. Michael Ungstrup and Mike Lind Rank are with Widex A/S, Lyngø, Denmark. Karin Rosenkranz is with the Department of Cognitive and Clinical Neuroscience, Central Institute of Mental Health, Mannheim, Germany.*

## References

- [1] E. Waterhouse, "New horizons in ambulatory electroencephalography," *IEEE Eng. Med. Biol. Mag.*, vol. 22, no. 3, pp. 74–80, 2003.
- [2] A. J. Casson, D. C. Yates, S. J. M. Smith, J. S. Duncan, and E. Rodriguez-Villegas, "Wearable electroencephalography," *IEEE Eng. Med. Biol. Mag.*, vol. 29, no. 3, pp. 44–56, 2010.
- [3] D. Looney, C. Park, P. Kidmose, M. L. Rank, M. Ungstrup, K. Rosenkranz, and D. P. Mandic, "An in-the-ear platform for recording electroencephalogram," in *Proc. Int. Conf. IEEE Eng. Med. Biol. Soc. (EMBC)*, 2011, pp. 6882–6885.
- [4] P. Kidmose, D. Looney, and D. P. Mandic, "Auditory evoked responses from Ear-EEG recordings," in *Proc. Int. Conf. IEEE Eng. Med. Biol. Soc. (EMBC)*, to be published.
- [5] M. Duta, C. Alford, S. Wilson, and L. Tarassenko, "Neural network analysis of the mastoid EEG for the assessment of vigilance," *Int. J. Human-Comput. Interaction*, vol. 17, no. 2, pp. 171–195, 2004.
- [6] M. Z. Poh, N. C. Swenson, and R. W. Picard, "Motion-tolerant magnetic earring sensor and wireless earpiece for wearable photoplethysmography," *IEEE Trans. Inform. Technol. Biomed.*, vol. 14, no. 3, pp. 786–794, 2010.
- [7] G. A. Pressler, J. P. Mansfield, H. Pasterkamp, and G. R. Wodicka, "Detection of respiratory sounds within the ear canal," in *Proc. Int. Conf. IEEE Eng. Med. Biol. Soc. (EMBC)*, 2002, vol. 2, pp. 1529–1530.
- [8] U. Lindemann, A. Hock, M. Stuber, W. Keck, and C. Becker, "Evaluation of a fall detector based on accelerometers: A pilot study," *Med. Biol. Eng. Comput.*, vol. 43, no. 5, pp. 548–551, 2005.

